



Immersion Cooler NeoCool Dip

Model BE201/201F/301

Instruction Manual

First Edition

- **Thank you for choosing BE series immersion Neo Cool Dip coolers from Yamato Scientific Co., Ltd.**
- **For proper equipment operation, please read this instruction manual thoroughly before use. Always keep equipment documentation safe and close at hand for convenient future reference.**

Warning: Read instruction manual warnings and cautions carefully and completely before proceeding.

**Yamato Scientific America Inc.
Santa Clara, CA**

Table of contents

1. SAFETY PRECAUTIONS	1
Explanation of Safety Symbols	1
Symbol Glossary	2
Warnings & Cautions.....	3
2. PRE-OPERATION PROCEDURES	4
Placement Precautions & Procedures	4
3. COMPONENT NAMES & FUNCTIONS.....	10
Main Unit Overview	10
4. OPERATION PROCEDURE.....	12
Main Operation.....	12
Cooling Capacity Curves (Reference Data)	13
Choosing Coolant for Low-Temp Applications (Reference Data)	15
5. HANDLING PRECAUTIONS	16
6. INSPECTION & MAINTENANCE	17
7. STORAGE & DISPOSAL	18
Extended Storage / Unit Disposal	18
Disposal Considerations	18
8. TROUBLESHOOTING	19
Troubleshooting Guide.....	19
9. SERVICE & REPAIR	20
10. SPECIFICATIONS.....	21
11. WIRING DIAGRAM	22
12. LIST OF HAZARDOUS SUBSTANCES	23

1. SAFETY PRECAUTIONS

Explanation of Safety Symbols

A Word Regarding Symbols

Various symbols are provided throughout this text and on equipment to ensure safe operation. Failure to comprehend the operational hazards and risks associated with these symbols may lead to adverse results as explained below. Become thoroughly familiar with all symbols and their meanings by carefully reading the following text regarding symbols before proceeding.

 **Warning** Signifies a situation which may result in serious injury or death (Note 1)

 **Caution** Signifies a situation which may result in minor injury (Note 2) and/or property damage (Note 3)

(Note 1) Serious injury is defined as bodily wounds, electrocution, bone breaks/fractures or poisoning, which may cause debilitation requiring extended hospitalization and/or outpatient treatment.

(Note 2) Minor injury is defined as bodily wounds or electrocution, which will not require extended hospitalization or outpatient treatment.

(Note 3) Property damage is defined as damage to facilities, equipment, buildings or other property. (Note 1) Serious injury is defined as bodily wounds,

Symbol Meanings

 Signifies warning or caution.
Specific explanation will follow symbol.

 Signifies restriction.
Specific restrictions will follow symbol.

 Signifies an action or actions which operator must undertake.
Specific instructions will follow symbol.

1. SAFETY PRECAUTIONS

Symbol Glossary

Warning



General Warning



Danger!: High Voltage



Danger!: Extremely Hot



Danger!: Moving Parts



Danger!: Blast Hazard

Caution



General Caution



Caution: Shock Hazard!



Caution: Burn Hazard!



Caution: Do Not Heat Without Water!



Caution: May Leak Water!



Caution: Water Only



Caution: Toxic Chemicals

Restriction



General Restriction



No Open Flame



Do Not Disassemble



Do Not Touch

Action



General Action Required

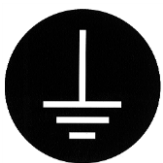

Connect Ground Wire



Level Installation Required

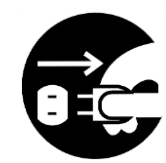

Disconnect Power



Inspect Regularly

1. SAFETY PRECAUTIONS

Warnings & Cautions



Never operate equipment near combustible gases/fumes.

Do not install or operate CF301 unit near flammable or explosive gases/fumes. Unit is NOT fire or blast resistant. Negligent use could cause a fire/explosion. See "List of Hazardous Substances" (P.24).



Always ground equipment.

Always ground this unit properly to avoid electric shock.



DO NOT operate equipment when abnormalities are detected.

If smoke or unusual odors begin emitting from unit, or if any other abnormalities are detected, terminate operation immediately, turn off main power switch (Earth Leakage Breaker - "ELB") and disconnect power cable. Continued operation under such conditions may result in fire or electric shock.



DO NOT operate with bundled or tangled power cable.

Operating unit with the power cable bundled or otherwise tangled, may cause power cable to overheat and/or catch fire.



DO NOT damage power cable.

Damaging the power cable by forcibly bending, pulling or twisting may cause fire or electric shock to the operator.



DO NOT process hazardous substances.

Never process explosive or flammable items. Fire or explosion may result. See "List of Hazardous Substances" (P.24) for more information on these items.



DO NOT handle flammable substances without proper ventilation.

Be sure there is adequate ventilation when working with certain flammable substances (such as ethanol, etc.), which evaporate quickly at or below room temperature, and emit flammable fumes. Insufficient ventilation may cause a fire or explosion. See "List of Hazardous Substances" (P.24).



NEVER disassemble or modify equipment.

Attempting to dismantle or modify unit in any way, may cause malfunction, fire or electric shock.



Caution



DO NOT operate equipment during thunderstorms.

In the event of a thunderstorm, terminate operation and turn off main power switch (ELB) immediately. A direct lightning strike may cause damage to equipment, or result in fire or electric shock.

2. PRE-OPERATION PROCEDURES

Placement Precautions & Procedures



Warning

1. Ground wire MUST be connected properly.



- Ground wire must be connected to a proper grounding line or terminal in order to prevent electric shock.



- Never connect ground wire to gas lines or water pipes.
- Never connect ground wire to telephone grounding lines or to lightning conductor rods. Doing so may result in fire or electrical shock.
- Never insert multiple plugs into a single outlet. Doing so may result in power cable overheating, fire or drop in voltage.

Connect to grounded outlet

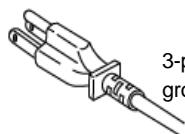

3-pronged plug with ground

Outlet with ground receptacle

Use ground adapter for ungrounded outlets

Ungrounded outlet

115V AC only



Ground wire

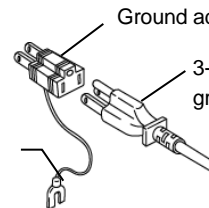

Ground adapter

3-pronged plug with ground

Outlet with no ground receptacle

Ground adapter

When no ground terminal is found:

- Grounding to Electrical Equipment Technical Standards, Section 19, class D (Grounding Resistance Max. 100Ω) is required in Japan. Contact a local dealer, electrician, or Yamato Sales office for location-specific electrical requirements.

- Insert grounded plug into ground adapter. Connect grounding wire (green) from ground adapter to a ground terminal.

2. Place in suitable locations.



Do not place BE series unit:

- where flammable or corrosive gases/fumes are generated.
- where external temperature will exceed 35°C, will fall below 5°C or will fluctuate.
- in excessively humid or dusty locations.
- where there is constant vibration.
- where power supply is erratic.
- in direct sunlight or outdoors



- Place unit in locations with sufficient space, and ventilation as specified as below.

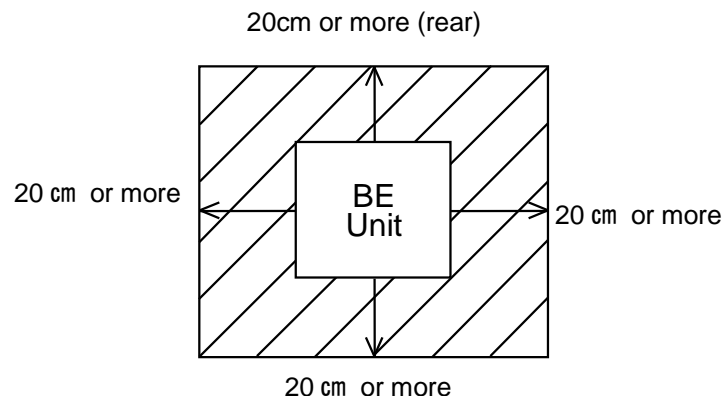

2. PRE-OPERATION PROCEDURES

Placement Precautions & Procedures

 **Warning**

3. Place in locations free of flammables and explosives.



- Never place or operate unit near flammables or explosives. BE unit is NOT fire or blast resistant. Simply switching the main power switch (ELB) "ON" or "OFF" can produce a spark, which could relay during operation, causing a fire or explosion when near flammable or explosive fluids, chemicals or gases/fumes. See "List of Hazardous Substances" (P.24).

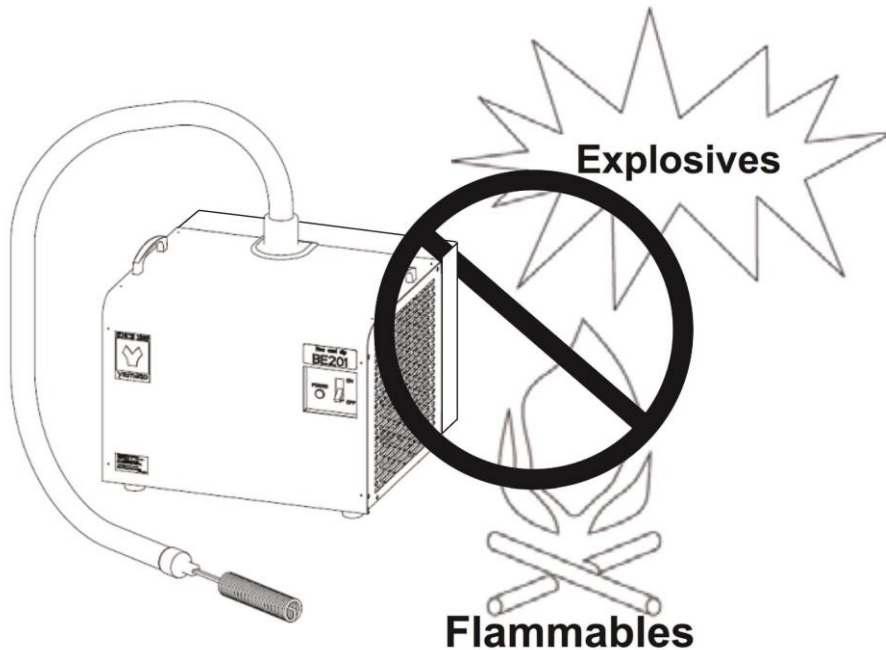

4. DO NOT disassemble or modify.



- Attempting to disassemble or modify this unit in any way may result in malfunction, fire or electric shock.

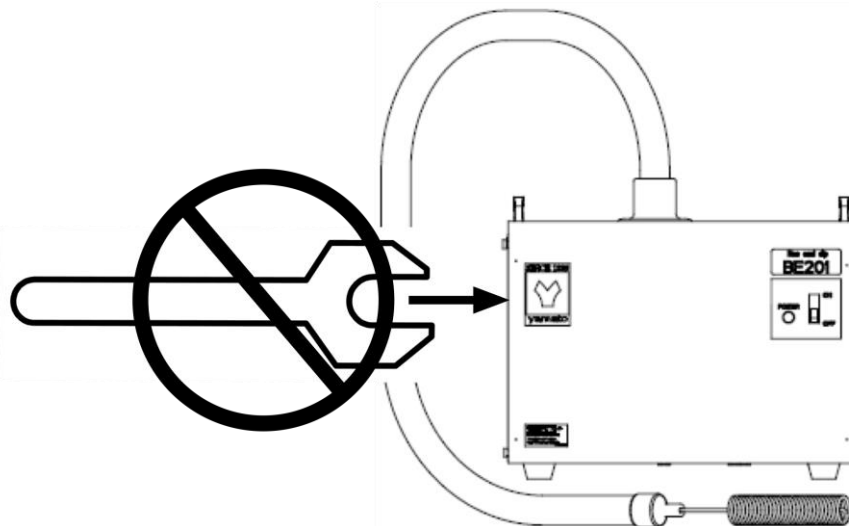

2. PRE-OPERATION PROCEDURES

Placement Precautions & Procedures

Warning

5. Place in dry locations.



Place unit where it will be free from liquid spray and other moisture. Failure to do so may result in control mechanisms or internal components becoming wet, causing malfunction, electrical shock and/or fire.

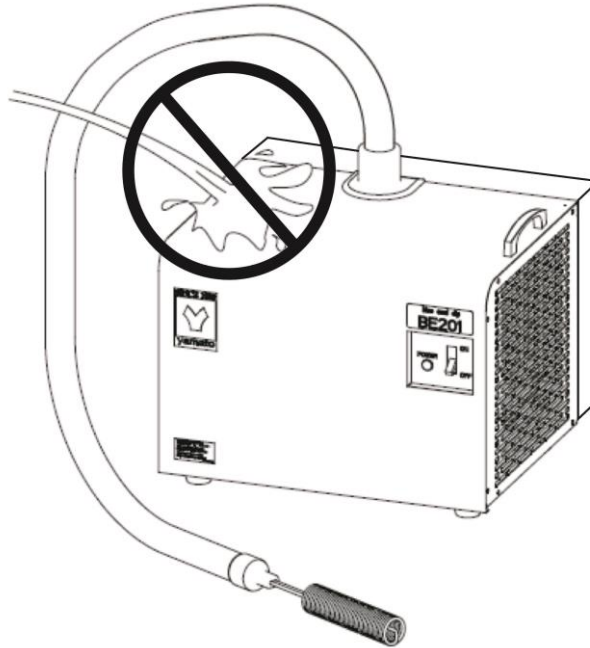

Caution

6. Place on level surfaces.



Place unit on a level and even surface. Failure to do so may result in abnormal vibrations or noise and damage to the refrigeration system.

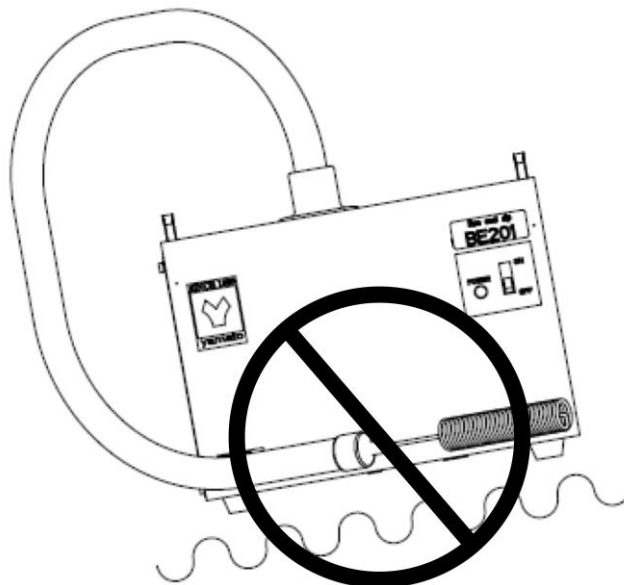

2. PRE-OPERATION PROCEDURES

Placement Precautions & Procedures



Caution

7. DO NOT forcibly pull or excessively bend cooling coil hose.



Handle cooling coil hose with care. Pulling on or bending hose to a radius of more than 50mm may break cooling line and result in malfunction or other equipment damage.

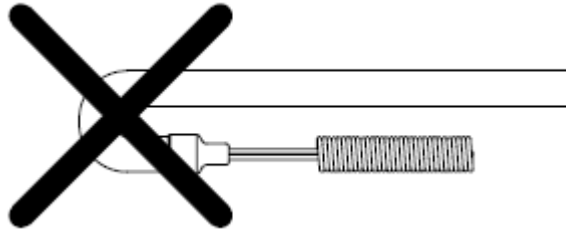

8. Connect to a properly rated power supply.



Connect power cable to a suitable facility outlet or terminal, according to the following electrical requirements.

Power requirements:	BE201 (50/60Hz) Single phase	115V	2.6A/2.0A	Max.3.0A
	BE201F (50/60Hz) Single phase	115V	3.6A/2.0A	Max.3.0A
	BE301 (50/60Hz) Single phase	115V	4.7A/4.3A	Max.5.5A

1. Check the line voltage on outlet or terminal to be used and properly evaluate whether to utilize a line being shared by other equipment. If the unit is not activated by turning on the main power switch (ELB), take an appropriate course of action, such as connecting unit to a dedicated power source.
2. If multiple power cables are connected to a single outlet, input voltage to unit may drop, causing degraded cooling and temperature control performance.



Never connect ground wire to gas lines, water lines or telephone grounding lines. Fire or electric shock may result.

9 Handle power cable with care.



Never operate unit with power cable bundled or tangled; and do not modify, bend, forcibly twist or pull on power cable. Doing so may cause fire and/or electrical shock.

Do not risk damage to power cable by positioning it under desks or chairs, or having it pinched between objects. Doing so may cause fire and/or electrical shock.

Do not place power cable near kerosene/electric heaters or other heat-generating devices. Doing so may cause power cable insulation to overheat, melt and/or catch fire, which may



Turn off main power switch (ELB) immediately and disconnect from facility terminal or outlet, if power cable becomes partially severed or damaged in any way. Failure to do so may result in fire or electric shock. Contact a local dealer or Yamato sales office for information about replacing power cable if it is damaged.

Always connect power cable to appropriate facility outlet or terminal.

2. PRE-OPERATION PROCEDURES

Placement Precautions & Procedures



Caution

10. Place in a safe, well-ventilated area.



- In the event of an earthquake or other unforeseen incident, equipment may unexpectedly shift or fall, causing injury. Taking preventative steps to install unit in a safe location, away from room access doors and out of harm's way is strongly recommended.
- Place unit so that intake and heat vents (see "Main Unit Overview" on P.11 & 12 for location) are unobstructed and allowed to adequately draw in air and diffuse heat. Failure to do so may cause excessive internal heat, resulting in degraded performance, malfunction or fire. See placement guide on P.5 above.

2. PRE-OPERATION PROCEDURES

Placement Precautions & Procedures

11. Select anti-freeze for container based on operating temperature.



- Choose an applicable fluid for cooling relative to objective temperature.
If objective temperature is more than 10°C, use tap water or softened tap water
If objective temperature is less than 10°C, use an antifreeze solution, such as Naiburain.

⌘ DO NOT use purified and/or deionized water as coolant.

The ready-to-use Raku-raku line of Naiburain solutions from Yamato Scientific is recommended.

Contact a local dealer or Yamato sales office to purchase Raku-raku Naiburain solutions.

Name	Product Code	Concentration (Wt%)	Min. STD Temperature	Container Size (in liters)
Raku-raku Solution: Z16005	756071	60%	-20°C	5L
Raku-raku Solution: Z16010	756072			10L
Raku-raku Solution: Z10005	756073	100%	-30°C	5L
Raku-raku Solution: Z10010	756074			10L
Raku-raku Solution: NFP6005	756075	60%	-10°C	5L
Raku-raku Solution: NFP6010	756076			10L

Observe the following in order to prevent malfunction and personal injury:

- Antifreeze concentration may become decreased after extended use.
Check concentration or change entirely on a regular basis.
- If only tap water is used, change more frequently.
- Do not use well water, purified water or deionized water.
- Degraded unit performance may be caused by using heavy or viscous antifreeze fluids, such as Fluorinert (by 3M), GALDEN (by Daitoku Tech), etc.
- Never use the following substances in BE units.
 - Corrosive chemicals
 - Solutions which become corrosive when heated, such as Fluorinert (by 3M), etc.
 - Solutions which emit harmful fumes, such as methanol

If an antiseptic agent is to be used, confirm material constitution of components with which fluid will be in contact and whether fluid will harm these components, before selecting.

- Assure sufficient ventilation when ethanol or other highly flammable fluids are used as antifreeze. Never operate unit near open flame or other ignition sources (static electricity, etc.).

3. COMPONENT NAMES & FUNCTIONS

Main Unit Overview

BE201 front view

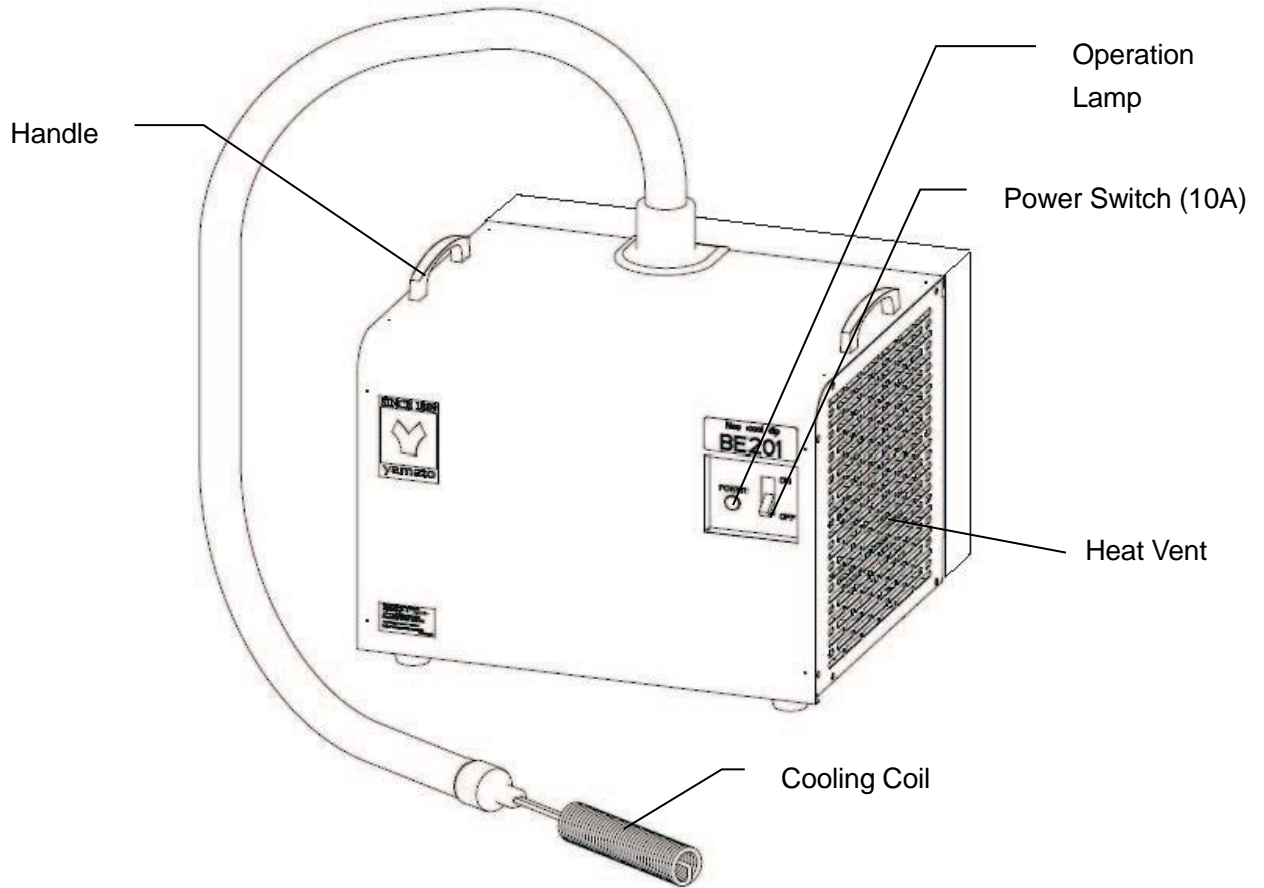

BE201 rear view

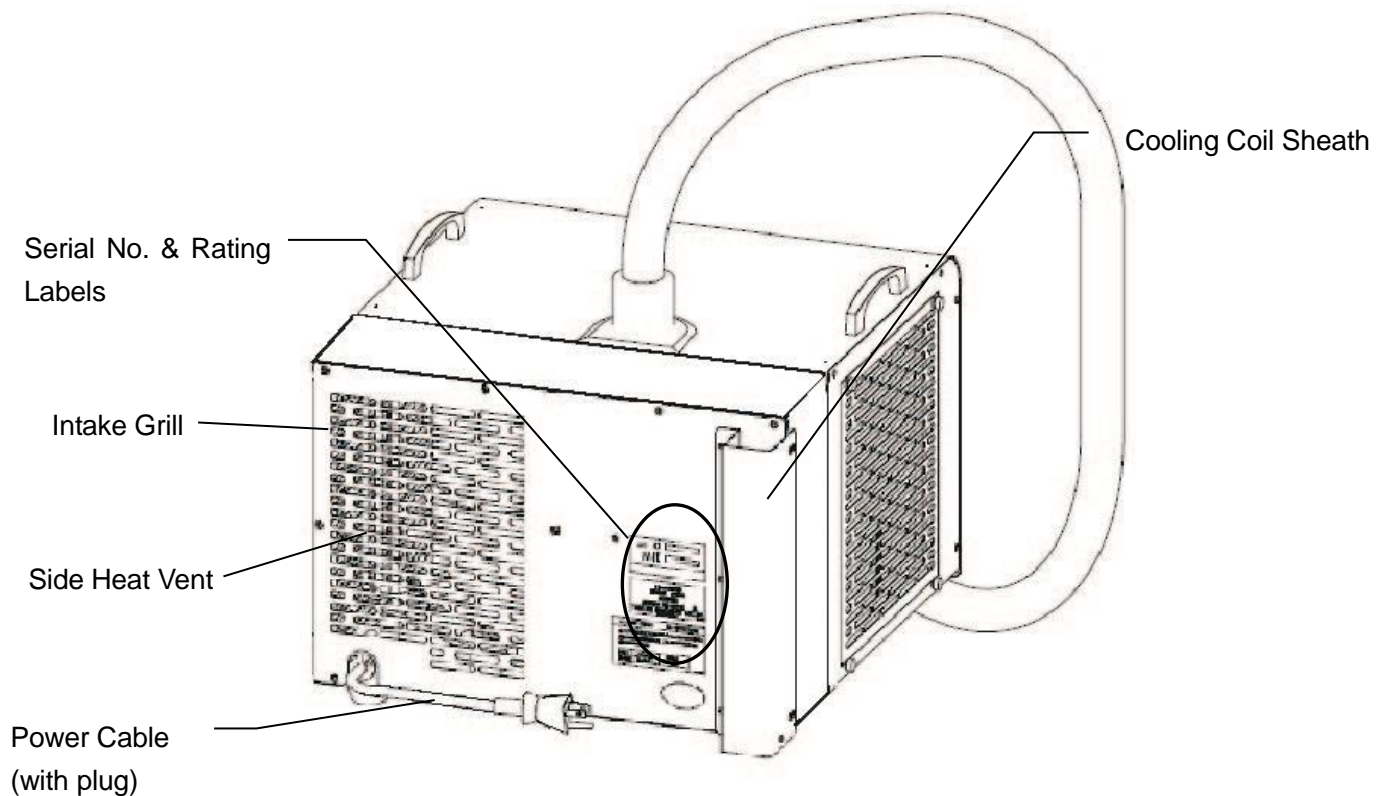

3. COMPONENT NAMES & FUNCTIONS

Main Unit Overview

BE201F/301 front view

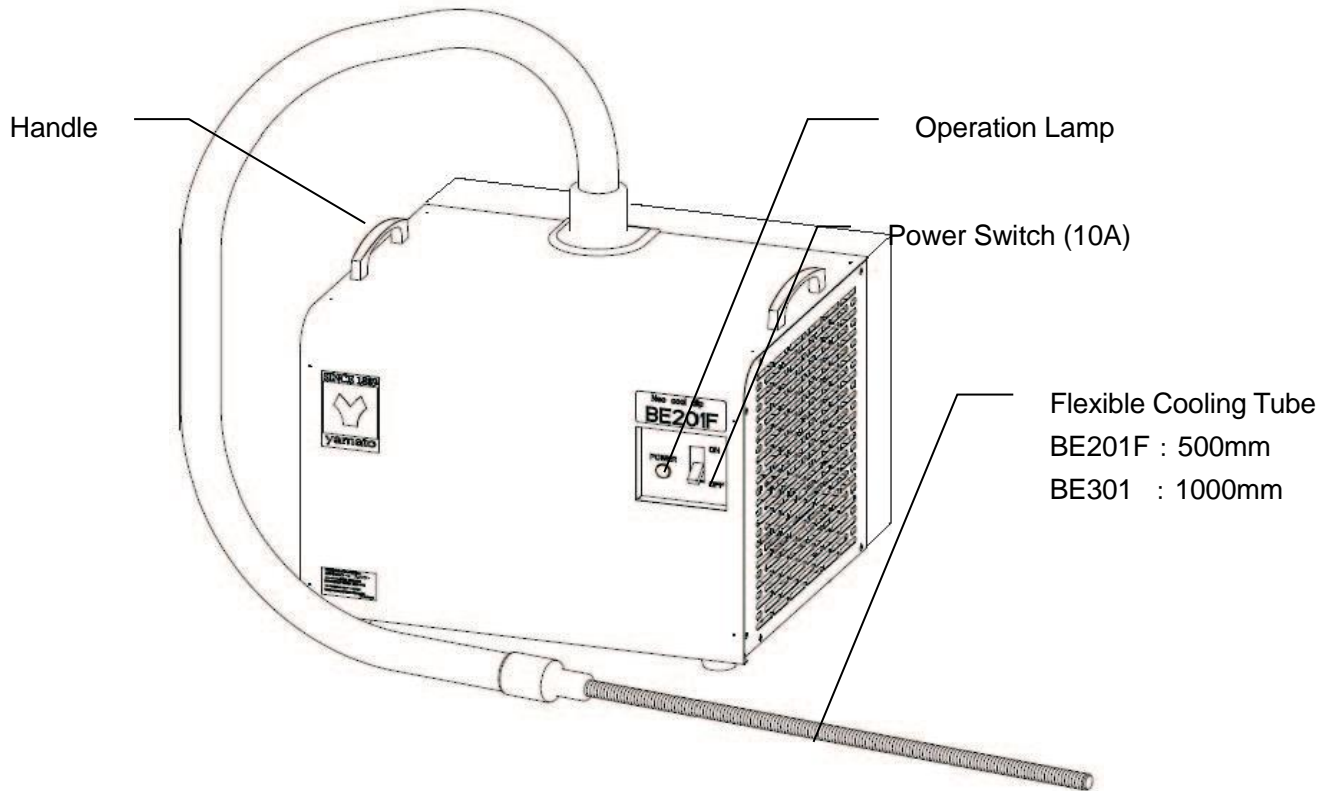

BE201F/301 rear view

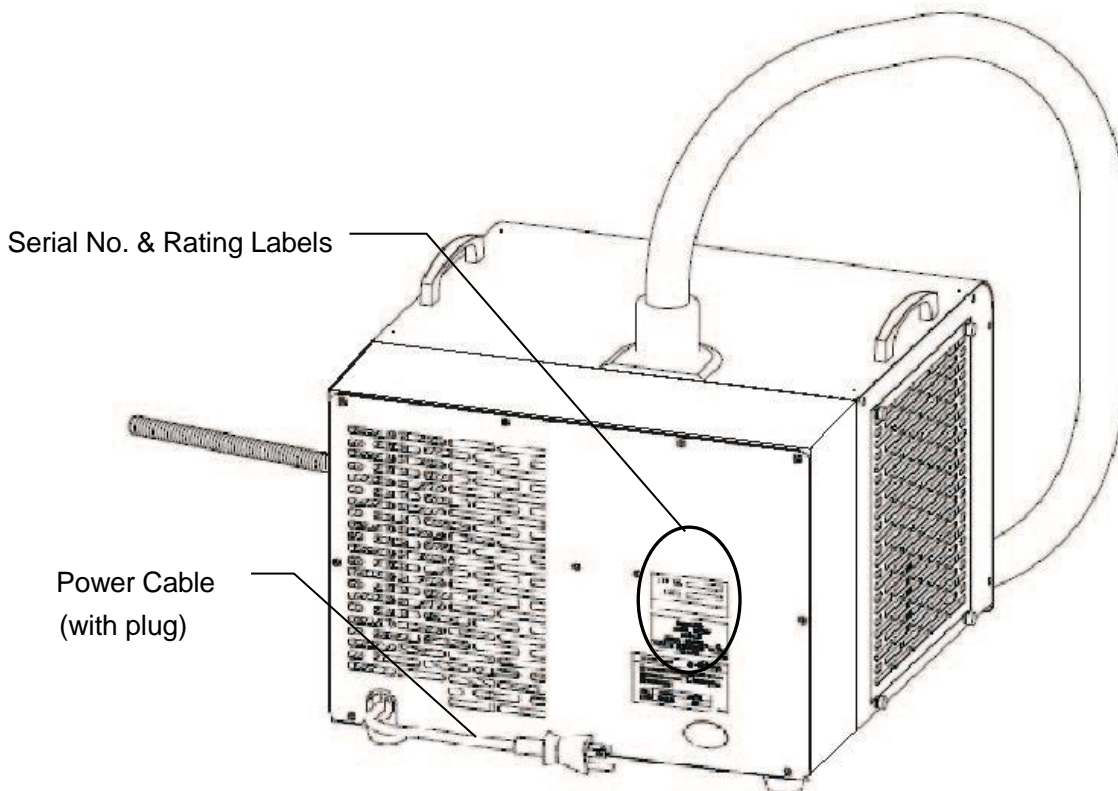

4. OPERATION PROCEDURE

Main Operation

Immerse cooling coil in fluid as shown in diagram below. Turn power switch (ELB) “ON” to start operation.

1. Immerse cooling coil.

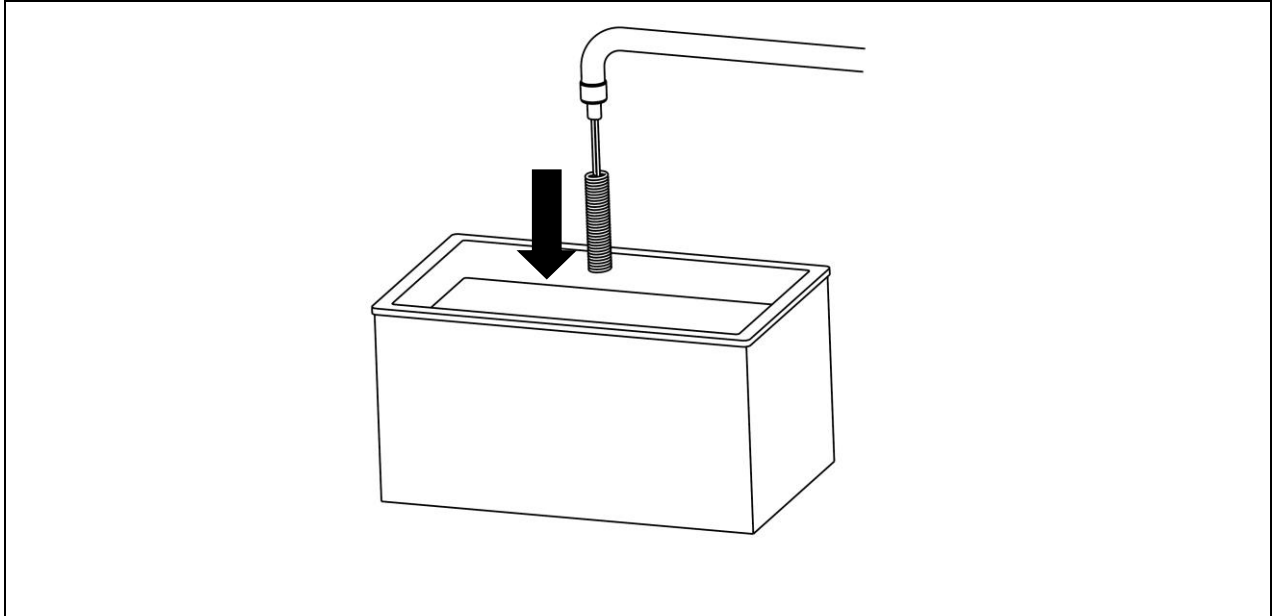

2. Turn power “ON”.

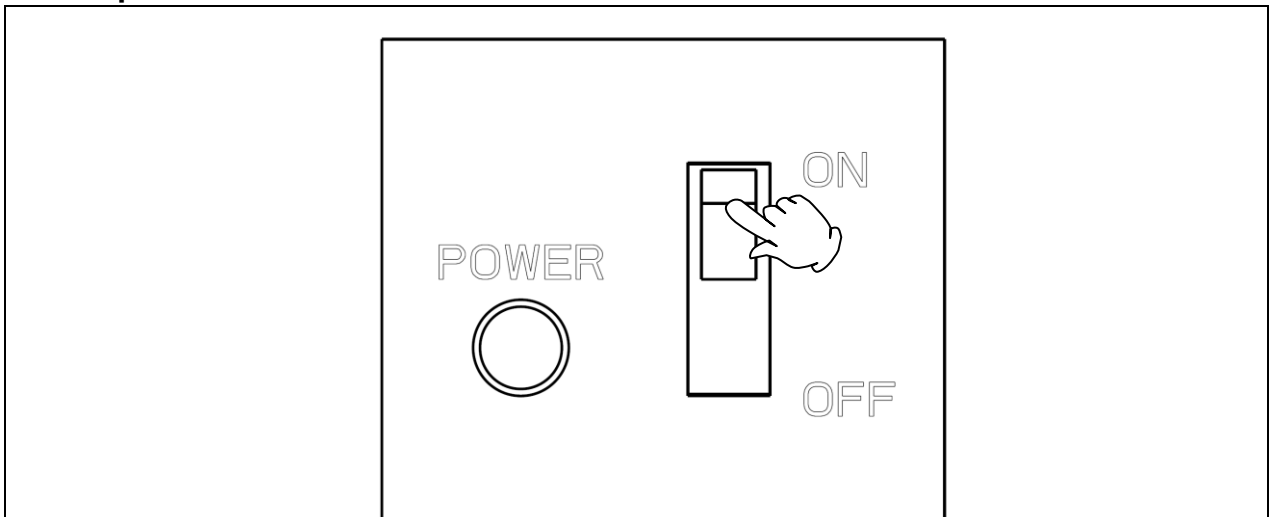

- Wait at least five minutes to resume after halting an operation (e.g. turning power off). DO NOT turn power switch “ON” and “OFF” repeatedly within a short timeframe. Damage to the refrigeration system may result.
- Avoid operating unit continuously at fluid temperatures above 35°C.

4. OPERATION PROCEDURE

Cooling Capacity Curves (Reference Data)



The following graphs show cooling capacities and characteristics of each BE unit by model. Findings may vary with external temperature, fluid volume, etc. Use graph values as reference only.

Analysis provisions

- External temperature : 23°C
- Power : 115V AC
- CPM : 50Hz
- Antifreeze fluid : 60% Naiburain solution (covered, stirred and heat insulated)
- Fluid quantity : BE201/201F: 5 ℓ BE301: 5 ℓ /10ℓ
- Temp sensor placement : container center

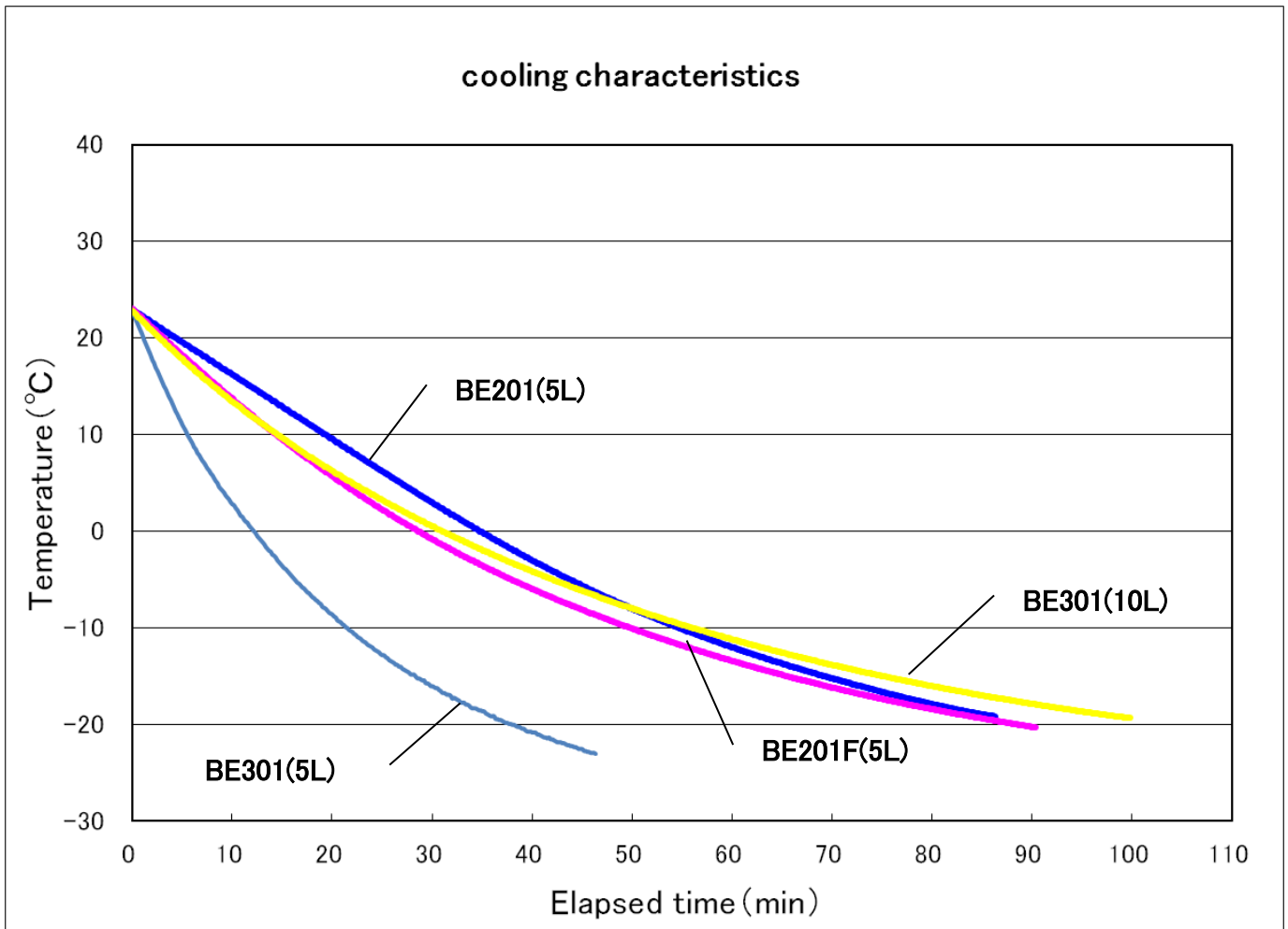

4. OPERATION PROCEDURE

Cooling Capacity Curves (Reference Data)

Analysis provisions

- Room temperature : 20°C
- Power supply : 115V AC
- CPM : 50Hz
- Antifreeze fluid : 60% Naiburain solution (covered, stirred and heat insulated)
- Fluid quantity : BE201/201F: 5 ℓ BE301: 10ℓ
- Temp sensor placement : container center

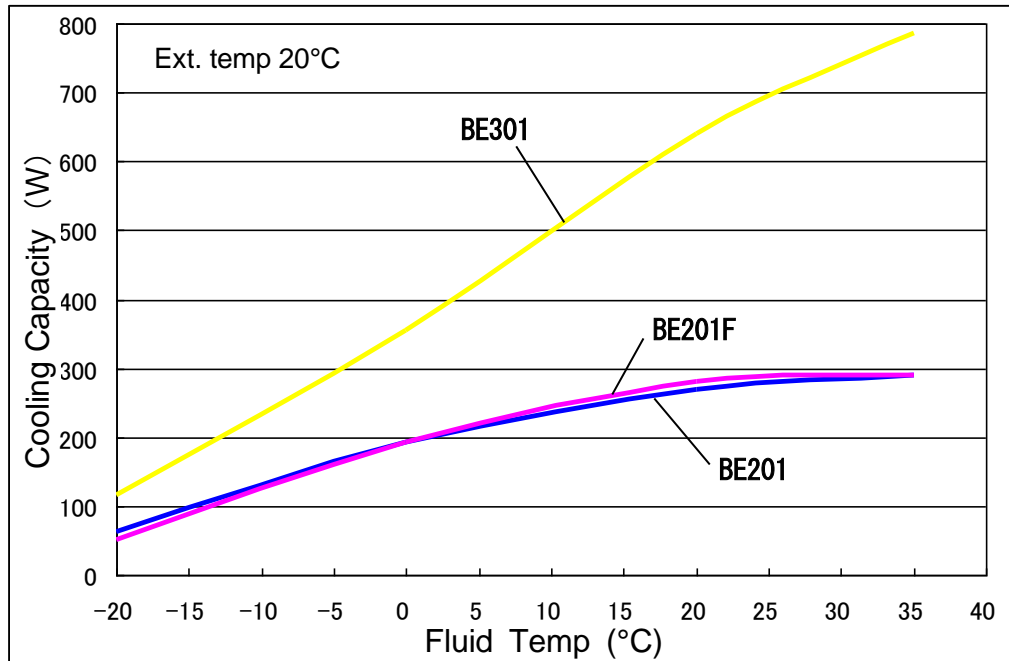

4. OPERATION PROCEDURE

Choosing Coolant for Low-Temp Applications (Reference Data)

An anti-freeze coolant solution is required for applications below 10°C. Select a Naiburain® product with freezing point of 10°C or more below objective temperature.

See “select coolant based on operating temperature” on P.10.

Naiburain product by type

Product Name	Z1, Z1-K		RH		NFP	
	50Wt%	100 Wt%	50Wt%	100 Wt%	50Wt%	100 Wt%
Boiling Point (in °C)	104	117	105	118	102	107
Specific Resistance (in $\Omega \cdot \text{cm}$ at 25°C)	625	1250	270	440	530	970
Conductivity (in $\text{S} \cdot \text{m}^{-1}$ at 25°C)	0.160	0.080	0.370	0.227	0.189	0.103
Steam Pressure (KPa at 20°C)	1.7	0.5	1.7	0.5	2.3	1.3
Freezing Point (°C)	-21	Below -50	-21	Below -50	-13.5	Below -50
Specific Gravity (at 20°C)	1.05	1.10	1.07	1.134	1.026	1.048
Viscosity (mPa·s at 20°C)	2.5	9.5	2.5	9.5	2.6	9.4
Specific Heat (cal/g at 20°C)	0.850	0.670	0.850	0.670	0.773	0.642

Naiburain® Freezing Points

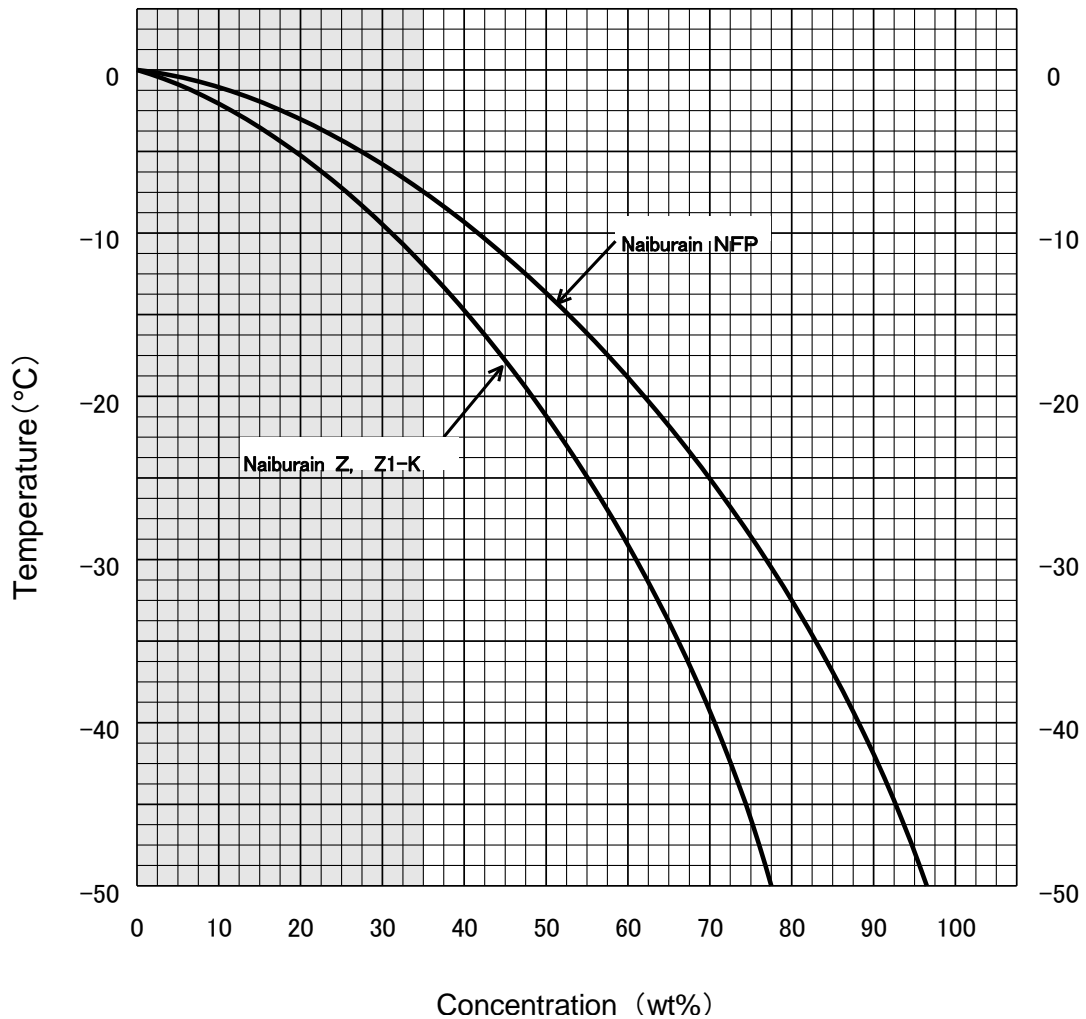

5. HANDLING PRECAUTIONS

Warning

1. DO NOT process hazardous substances.

 Never process explosive substances, flammable substances or substances that contain explosives or flammables with BE units. See “List of Hazardous Substances” on P.24.

2. DO NOT operate equipment when abnormalities are detected.

 If unit begins emitting smoke or abnormal odors for reasons unknown, turn off main power (ELB) immediately, disconnect power cable from power supply, and contact a local dealer or Yamato sales office for assistance. Continued use without addressing abnormalities may cause fire or electric shock, resulting in serious injury or death. Never attempt to disassemble or repair unit. Repairs should always be performed by a certified technician.

Caution

1. DO NOT climb on equipment.

 Do not attempt to climb onto unit or substitute it for a proper step ladder. Units are not designed to support bodily weight and damage may result. In addition, unit may become unstable and tip over or fall resulting in equipment damage, serious injury or death.

2. DO NOT place objects on equipment.

 Do not place any objects on unit. Doing so may cause unit to become unstable and tip over, resulting in possible equipment damage, injury or death.

3. DO NOT operate equipment during thunderstorms.

 In the event of a thunderstorm, turn off main power switch (ELB), and disconnect power cable immediately. A direct lightning strike may cause equipment damage fire or electric shock, resulting in serious injury or death.

4. DO NOT operate dry.

 Do not operate without cooling coil immersed in fluid. Malfunction or equipment damage may result.

5. Operate equipment as directed.

 Operate BE series units only as directed in this text. Utilizing equipment for anything other than that which it is intended may cause malfunction, damage, serious personal injury or death. Read instruction manual thoroughly before use. Likewise, using non-Yamato components to modify, customize or to otherwise attempt to improve unit design is not recommended and may void warranty.

6. Keep upright.

 Never tilt or place unit on its side while moving or transporting. Damage to refrigeration system may result. If briefly tilting unit to one side or the other is unavoidable during transport, refrain from turning power on for at least 24 hours after positioning unit upright.

6. INSPECTION & MAINTENANCE

Daily general maintenance and inspection is recommended to ensure optimal performance.

Warning

- Turn off power and disconnect power cable before conducting inspection and maintenance, unless otherwise necessary.
- Inspect and perform maintenance on unit when coolant is at room temperature.
- Do not attempt to disassemble unit.

Caution

- Clean unit using a soft, damp cloth.
- Never use benzene, paint thinner, scouring powder, scrubbing brush or other abrasives and solvents to clean unit. Superficial damage and/or discoloration, as well as deformity to some components may result.

Monthly maintenance.

- Test main power switch (ELB) function.
 1. Connect power cable.
 2. Turn power switch ON.
 3. Depress the red test switch with a fine-point object, such as a ballpoint pen, etc.
 4. If power switch turns OFF without delay, it is functioning normally.

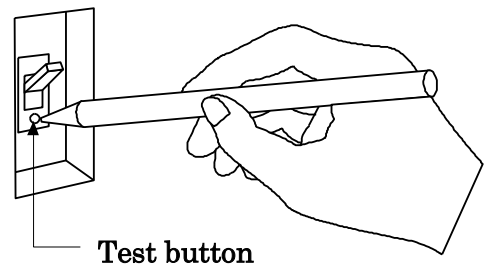

Condenser fin maintenance.

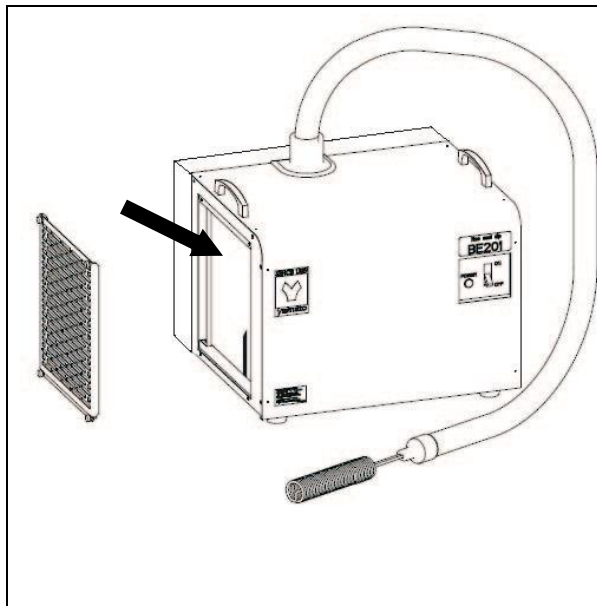

- Clogged condenser fins will degrade cooling performance and may result in refrigeration system malfunction. Cleaning intervals will vary depending on usage frequency and operating environment. Be sure to clean condenser fins periodically.
- Remove intake grill on left side of unit (4 screws) and clean dust from condenser fins using a vacuum cleaner or other suction-type cleaning device. Do not touch fins with bare hands or fingers. Laceration injuries may result. Do not bend or crush fins with cleaning device.

◆ Contact local dealer or Yamato sales office for further assistance.

7. STORAGE & DISPOSAL

Extended Storage / Unit Disposal



Caution



Warning

<p>To store or to place unit out of service:</p> <ul style="list-style-type: none"> • Turn power OFF and disconnect power cable. 	<p>Disposal:</p> <ul style="list-style-type: none"> • CF301 units use a Freon alternative refrigerant. Observe the Freon Collection Act and request the assistance of a professional. • Place out of reach of children. • Dispose of as bulky or industrial waste.
---	---

Disposal Considerations

Dispose of or recycle this unit in a responsible and environmentally friendly manner.

Yamato Scientific Co., Ltd. strongly recommends disassembling unit, as far as is possible, in order to separate parts and recycle them in contribution to preserving the global environment.

Major components and materials, comprising BE series units are listed in the table below:

Item	Composition
Main	
External casing	Electrogalvanized carbon steel paneling (SFCC), baked-on chemical-proof coating
Cooling coil	SUS304 Stainless steel
Labels	Polyethylene (PET) resin film
Caps	Synthesized rubber
Electrical	
Switches and relays	Composite of resin, copper and other materials
Circuit boards	Composite of fiber glass and other materials
Power cable	Composite of synthesized rubber coating, copper, nickel and other compounds
Refrigeration unit	Alloy of iron, copper, etc.
Internal plumbing	
Hose insulation	EPM
Plumbing lines	Copper
Condenser	Iron, copper, aluminum
Cooling medium	
Refrigerant	R134a(BE201/201F) R404A(BE301) (Consult specialist for handling refrigerant.)

8. TROUBLESHOOTING

Troubleshooting Guide

Troubles

Symptom	Possible Cause
Unit does not activate when power is turned ON.	<ul style="list-style-type: none">● Power cable not connected securely● Power failure in progress
Temperature does not decrease.	<ul style="list-style-type: none">● Temperature of fluid in basin is too high or refrigeration system is overloaded● Cooling coil has frozen● Condenser fins are clogged with dust● External temperature is excessively high● Intake vent is obstructed● Antifreeze fluid concentration is too low
Refrigeration system does not start.	<ul style="list-style-type: none">● Refrigeration system is in overload. Turn off power switch immediately, see possible causes for “temperature does not decrease”, above, and turn on refrigeration system again after several minutes.

Power failures.

In the event of a power failure, unit automatically returns to point of operation where power loss occurred and continues operating from that point when power is restored. If automatic restore feature is not desired after power is restored, turn main power switch OFF.

- ◆ If problem persists, turn off power immediately, disconnect power cable and call for service.

9. SERVICE & REPAIR

Requests for Repair

When a problem occurs, terminate operation immediately, turn off main power switch (ELB) and disconnect power cable.

Contact a local dealer or Yamato sales office for assistance.

The following information is required for all repairs.

- Model name
- Serial Number
- Date (year/month/day) of purchase
- Description of problem in as much detail as possible

} See production/rating label on unit. Refer to P.11 & 12 for location.

Guaranteed Supply Period for Repair Parts

Guaranteed maximum supply period for repair parts is 7 (seven) years from date of discontinuation for BE series NeoCool Dip immersion coolers. "Repair parts" is defined as components which, when installed, allow for continued unit operation.

10. SPECIFICATIONS

Device		Neo Cool Dip		
Model		BE201	BE201F	BE301
Operational external temperature range		5°C~35°C		
Performance ⌘ 1	Effective operating temp.	-20°C~35°C		
	Cooling capacity	Approx.190W at 0°C	Approx.190W at 0°C	Approx.350W at 0°C
60% Naiburain to water solution: 5L @20°C			60% Naiburain to water solution: 10L @20°C	
Configuration	Refrigeration system	Hitachi 160W reciprocating system		Hitachi 400W reciprocating system
	Cooling coil	Coiled tube	Flex tube	Flex tube
		Φ35×170mm SUS304	Φ15×500mm SUS304	Φ15×1000mm SUS304
Refrigerant, refrigerant amount	R134a 130g	R134a 130g	R404A 170g	
Safety functions		Overcurrent ELB		
Standard measurements	External dimensions ⌘ 2 (W×D×H mm)	W410×D410×H303 (Excluding flex tube, cooling coil and attachment clamps.)		
	Power supply (50/60Hz)	Single phase 115V 2.6A/2.0A Max.3.0A 10A/plug included	Single phase 115V 2.6A/2.0A Max.3.0A 10A/plug included	Single phase 115V 4.7A/4.3A Max.5.5A 10A/plug included
	Weight	Approx.26 kg	Approx.26 kg	Approx.28 kg
Included items		1 instruction manual		

⌘ 1 Performance based on AC115V power supply; 20°C±5°C external temperature; 65%RH±20% humidity; no load. Performance will vary depending on operation conditions..

⌘ 2 Protrusions excluded.

11. WIRING DIAGRAM

BE201/201F/301

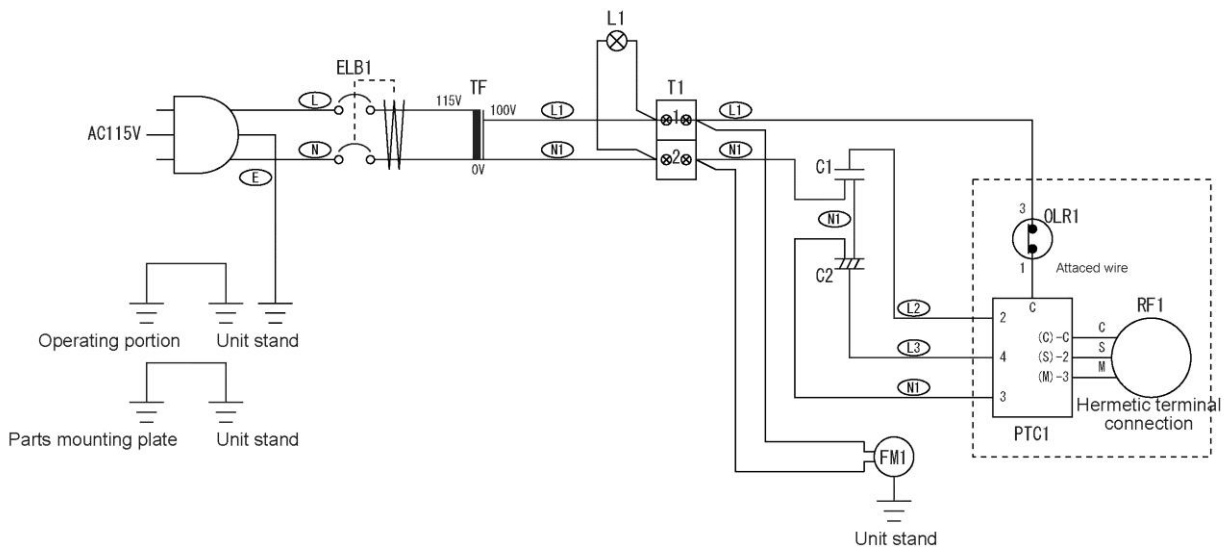

Symbol	Part name	Symbol	Part name
ELB1	Electric Leakage Breaker	OLR1	Over load relay
T1	Terminal block	C1	Operation capacitor
FM1	Fan motor	C2	Start capacitor
RF1	Capacitor	PTC1	PTC starting device
L1	Lamp	TF	Transformer

12. LIST OF HAZARDOUS SUBSTANCES



Never process explosive substances, flammable substances or substances that contain explosives or flammables.

Explosive Substances	①Nitroglycol, Glycerine trinitrate, Cellulose Nitrate and other explosive nitrate esters
	②Trinitrobenzen, Trinitrotoluene, Picric Acid and other explosive nitro compounds
	③Acetyl Hydroperoxide, Methyl Ethyl Ketone Peroxide, Benzoyl Peroxide and other organic peroxides
	④Metallic Azide, including Sodium Azide, etc.
Explosive Substances	①Metal "Lithium" ②Metal "Potassium" ③Metal "Natrium" ④Yellow Phosphorus
	⑤Phosphorus Sulfide ⑥Red Phosphorus⑦Phosphorus Sulfide
	⑧Celluloids, Calcium Carbide (a.k.a, Carbide)⑨Lime Phosphide⑩Magnesium Powder
	⑪Aluminum Powder ⑫Metal Powder other than Magnesium and Aluminum Powder
	⑬Sodium Dithionous Acid (a.k.a., Hydrosulphite)
Oxidizing Substances	①Potassium Chlorate, Sodium Chlorate, Ammonium Chlorate, and other chlorates
	②Potassium Perchlorate, Sodium Perchlorate, Ammonium Perchlorate, and other perchlorates
	③Potassium Peroxide, Sodium Peroxide, Barium Peroxide, and other inorganic peroxides
	④Potassium Nitrate, Sodium Nitrate, Ammonium Nitrate, and other nitrates
	⑤Sodium Chlorite and other chlorites
	⑥Calcium Hypochlorite and other hypochlorites
Flammable Substances	①Ethyl Ether, Gasoline, Acetaldehyde, Propylene Chloride, Carbon Disulfide, and other substances with ignition point at 30 or more degrees below zero.
	②n-hexane, Ethylene Oxide, Acetone, Benzene, Methyl Ethyl Ketone and other substances with ignition point between 30 degrees below zero and less than zero.
	③Methanol, Ethanol, Xylene, Pentyl n-acetate, (a.k.a.amyl n-acetate) and other substances with ignition point between zero and less than 30 degrees.
	④Kerosene, Light Oil, Terebinth Oil, Isopenthyl Alcohol(a.k.a. Isoamyl Alcohol), Acetic Acid and other substances with ignition point between 30 degrees and less than 65 degrees.
Combustible Gas	Hydrogen, Acetylene, Ethylene, Methane, Ethane, Propane, Butane and other gases combustible at 15°C at one air pressure.

Excerpt from Table 1, Hazardous Substances, of Cabinet Order of the Occupational Safety and Health Law (substances related to Articles 1, 6, and 9)

Limited liability

Always operate equipment in strict compliance to the handling and operation procedures set forth by this instruction manual.

Yamato Scientific Co., Ltd. assumes no responsibility for malfunction, damage, injury or death resulting from negligent equipment use.

Never attempt to disassemble, repair or perform any procedure on BE series unit which is not expressly mandated by this manual. Doing so may result in equipment malfunction, serious personal injury or death.

Notice

- **Instruction manual descriptions and specifications are subject to change without notice.**
- **Yamato Scientific Co., Ltd. will replace flawed instruction manuals (pages missing, pages out of order, etc.) upon request.**

Instruction Manual
Immersion Cooler NeoCool Dip
BE201/201F/301
First Edition: June 6, 2017

Yamato Scientific America Inc.

925 Walsh Avenue, Santa Clara, CA 95050

Phone: 800.292.6286 / 408.235.7725

<http://www.yamato-usa.com>